



Introduction

This high-quality Bourdon tube pressure gauge range have been designed especially for domestic and commercial heating system. They can be installed in isolation or as part of a valve or other multi part equipment.

Technical Specification

- Dial: Aluminum with black figures
- Window: Polycarbonate
- Pointer: Aluminum
- Case: Steel
- Connection: Back connection G1/4"
- Operation temperature: -40°C -65°C
- Pressure range: 0-6bar

Dimensions

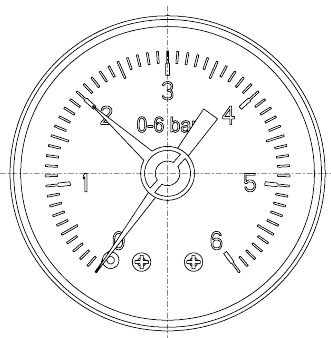
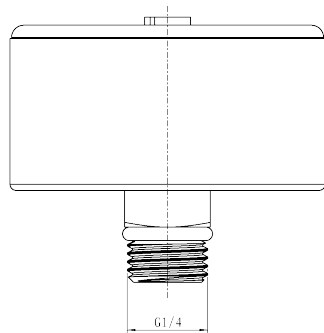

EV-G614BC Gauge 6 Bar 1/4" Back Connection